

## Zestawienie kolorystyczne - Artiko

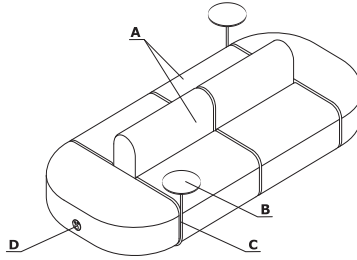

| Material | Kolor               | Artiko                 |          |            |              |  |  |  |  |  |  |  |  |  |  |  |  |  |  |  |
|----------|---------------------|------------------------|----------|------------|--------------|--|--|--|--|--|--|--|--|--|--|--|--|--|--|--|
|          |                     | A - Siedzisko, oparcie | B - Blat | C - Stelaż | D - Mediabox |  |  |  |  |  |  |  |  |  |  |  |  |  |  |  |
|          | Medley              | ✓                      |          |            |              |  |  |  |  |  |  |  |  |  |  |  |  |  |  |  |
|          | **Atlantic          | ✓                      |          |            |              |  |  |  |  |  |  |  |  |  |  |  |  |  |  |  |
|          | Vita                | ✓                      |          |            |              |  |  |  |  |  |  |  |  |  |  |  |  |  |  |  |
|          | ****Charles         | ✓                      |          |            |              |  |  |  |  |  |  |  |  |  |  |  |  |  |  |  |
|          | Go Check            | ✓                      |          |            |              |  |  |  |  |  |  |  |  |  |  |  |  |  |  |  |
|          | Mica                | ✓                      |          |            |              |  |  |  |  |  |  |  |  |  |  |  |  |  |  |  |
| Tkanina  | *Tkanina powierzona | III grupa              |          |            |              |  |  |  |  |  |  |  |  |  |  |  |  |  |  |  |
|          | Synergy             | III grupa              |          |            |              |  |  |  |  |  |  |  |  |  |  |  |  |  |  |  |
|          | ***Silvertex        | III grupa              |          |            |              |  |  |  |  |  |  |  |  |  |  |  |  |  |  |  |
|          | Tessa               | III grupa              |          |            |              |  |  |  |  |  |  |  |  |  |  |  |  |  |  |  |
|          | Oceanic             | III grupa              |          |            |              |  |  |  |  |  |  |  |  |  |  |  |  |  |  |  |
|          | Quest               | III grupa              |          |            |              |  |  |  |  |  |  |  |  |  |  |  |  |  |  |  |
|          | Grain               | III grupa              |          |            |              |  |  |  |  |  |  |  |  |  |  |  |  |  |  |  |
|          | Atlas               | IV grupa               |          |            |              |  |  |  |  |  |  |  |  |  |  |  |  |  |  |  |
|          | Skóra               | IV grupa               |          |            |              |  |  |  |  |  |  |  |  |  |  |  |  |  |  |  |

\* Zastosowanie tkaniny powierzonej wymaga przeprowadzenia prób tapicerskich, w celu sprawdzenia możliwości wykonawczych

\*\* Istnieje możliwość zamówienia produktu w pełnej kolorystyce Atlantic wg wzornika Gabriel w terminie nie krótszym niż 7 tygodni

\*\*\* Istnieje możliwość zamówienia produktu w pełnej kolorystyce Silvertex wg wzornika Spradling w terminie nie krótszym niż 15 dni roboczych

\*\*\*\* Istnieje możliwość zamówienia produktu w pełnej kolorystyce Charles wg wzornika Dekoma w standardowym terminie realizacji.

| Materiał | Kolor                              | Artiko                 |           |            |              |  |  |  |  |  |  |  |  |  |  |  |
|----------|------------------------------------|------------------------|-----------|------------|--------------|--|--|--|--|--|--|--|--|--|--|--|
|          |                                    | A - Siedzisko, oparcie | B - Blat  | C - Stelaż | D - Mediabox |  |  |  |  |  |  |  |  |  |  |  |
| Metal    | M010 - jasny szary półmat RAL 7044 |                        | Szary     | ✓          |              |  |  |  |  |  |  |  |  |  |  |  |
|          | M014 - czerwony półmat RAL 3016    |                        | Czerwony  | ✓          |              |  |  |  |  |  |  |  |  |  |  |  |
|          | M027 - niebieski półmat RAL5003    |                        | Niebieski | ✓          |              |  |  |  |  |  |  |  |  |  |  |  |
|          | M115 - czarny półmat RAL 9005      |                        | Czarny    | ✓          |              |  |  |  |  |  |  |  |  |  |  |  |
|          | Czarny                             |                        |           |            | ✓            |  |  |  |  |  |  |  |  |  |  |  |

**Opis techniczny**

- 1 Oparcie** - stelaż z płyty wiórowej; pianka cięta, gęstość 35 kg/m<sup>3</sup>; tapicerowane
- 2 Siedzisko** - stelaż z płyty wiórowej; pianka cięta, gęstość 35 kg/m<sup>3</sup>; tapicerowane
- 3 Biał** - MDF 16 mm, lakierowany - w kolorze stelaża
- 4 Stelaż** - metal malowany proszkowo 18 mm
- 5 OPCJA Z DOPŁATĄ** - Mediabox M07 - kolor: czarny, biały; 1 gniazdo zasilające 230V + 1 x USB charger + 1 x RJ45, 2000mA

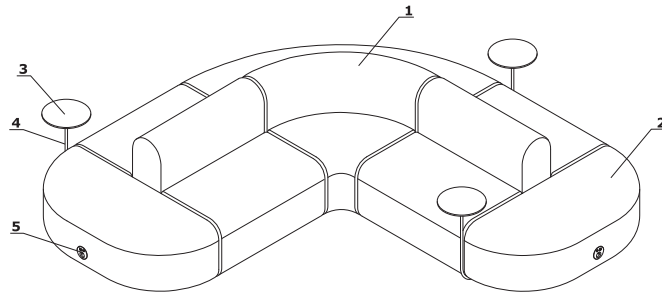

Uwaga! W przypadku tworzenia układu z elementów składowych do zamówienia należy dołączyć aranżacje.

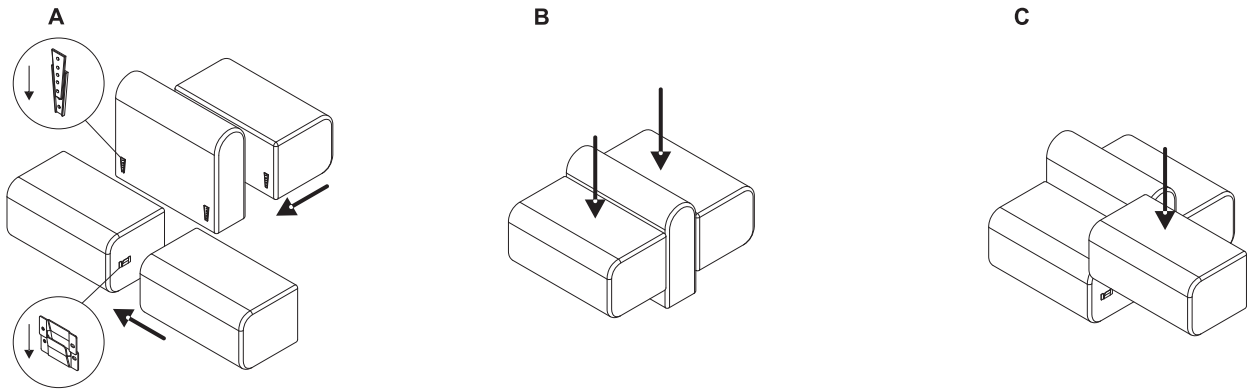
**Montaż**

| Symbol      | Cena netto<br>PLN | Wymiary |     |    |    |     | Waga<br>Obj.<br>Opak.                   | Elementy składowe  |
|-------------|-------------------|---------|-----|----|----|-----|---|--------------------|
|             |                   | W1      | W2  | D1 | D2 | H   |   |                    |
| <b>AT24</b> | <b>8290,-</b>     | 2840    | 770 |    |    | 750 | 98 kg<br>1.466 m <sup>3</sup><br>4 szt. | AT02L+AT02P+2xAT03 |

| Dodatkowa dopłata |                 |           |  |  |  |
|-------------------|-----------------|-----------|--|--|--|
| III grupa cenowa  | IV grupa cenowa | Stolik x1 |  |  |  |
| 1272,-            | 2206,-          | 545,-     |  |  |  |

| Symbol      | Cena netto<br>PLN | Wymiary |     |    |    |     | Waga<br>Obj.<br>Opak.                    | Elementy składowe       |
|-------------|-------------------|---------|-----|----|----|-----|--|-------------------------|
|             |                   | W1      | W2  | D1 | D2 | H   |  |                         |
| <b>AT11</b> | <b>10980,-</b>    | 3740    | 770 |    |    | 750 | 131 kg<br>1.894 m <sup>3</sup><br>6 szt. | AT02L+AT04+AT02P+3xAT03 |

| Dodatkowa dopłata |                 |           |           |  |  |
|-------------------|-----------------|-----------|-----------|--|--|
| III grupa cenowa  | IV grupa cenowa | Stolik x1 | Stolik x2 |  |  |
| 1720,-            | 2988,-          | 545,-     | 1090,-    |  |  |

| Symbol      | Cena netto<br>PLN | Wymiary |     |    |    |     | Waga<br>Obj.<br>Opak.                    | Elementy składowe         |
|-------------|-------------------|---------|-----|----|----|-----|--|---------------------------|
|             |                   | W1      | W2  | D1 | D2 | H   |  |                           |
| <b>AT15</b> | <b>13670,-</b>    | 4640    | 770 |    |    | 750 | 164 kg<br>2.321 m <sup>3</sup><br>8 szt. | AT02L+2xAT04+AT02P+4xAT03 |

| Dodatkowa dopłata |                 |           |           |           |  |
|-------------------|-----------------|-----------|-----------|-----------|--|
| III grupa cenowa  | IV grupa cenowa | Stolik x1 | Stolik x2 | Stolik x3 |  |
| 2168,-            | 3770,-          | 545,-     | 1090,-    | 1635,-    |  |

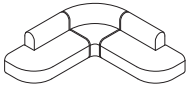
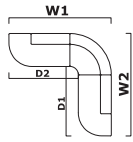
|   |                |         |      |      |      |     |  |                              |
|---|----------------|---------|------|------|------|-----|--|------------------------------|
| Symbol  | Cena netto PLN | Wymiary |      |      |      |     | Waga Obj. Opak.                          | Elementy składowe            |
|   |                | W1      | W2   | D1   | D2   | H   |  |                              |
| <b>AT23</b>   | <b>11795,-</b> | 2310    | 2310 | 1540 | 1540 | 750 | 133 kg<br>2.186 m <sup>3</sup><br>6 szt. | AT02L+AT05+AT02P+2xAT03+AT06 |

| Dodatkowa dopłata |                 |           |  |  |  |
|-------------------|-----------------|-----------|--|--|--|
| III grupa cenowa  | IV grupa cenowa | Stolik x1 |  |  |  |
| 1876,-            | 3260,-          | 545,-     |  |  |  |

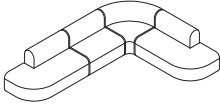
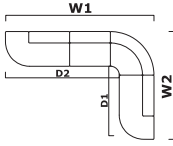
|   |                |         |      |      |      |     |  |                                   |
|---|----------------|---------|------|------|------|-----|--|-----------------------------------|
| Symbol  | Cena netto PLN | Wymiary |      |      |      |     | Waga Obj. Opak.                          | Elementy składowe                 |
|   |                | W1      | W2   | D1   | D2   | H   |  |                                   |
| <b>AT08</b>   | <b>14485,-</b> | 3210    | 2310 | 1540 | 2440 | 750 | 166 kg<br>2.614 m <sup>3</sup><br>8 szt. | AT02L+AT04+AT05+AT02P+3xAT03+AT06 |

| Dodatkowa dopłata |                 |           |           |  |  |
|-------------------|-----------------|-----------|-----------|--|--|
| III grupa cenowa  | IV grupa cenowa | Stolik x1 | Stolik x2 |  |  |
| 2324,-            | 4042,-          | 545,-     | 1090,-    |  |  |

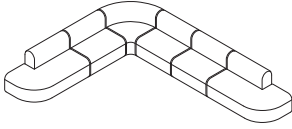
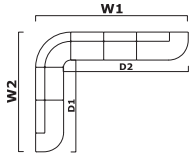
|   |                |         |      |      |      |     |   |                                     |
|---|----------------|---------|------|------|------|-----|---|-------------------------------------|
| Symbol  | Cena netto PLN | Wymiary |      |      |      |     | Waga Obj. Opak.                           | Elementy składowe                   |
|   |                | W1      | W2   | D1   | D2   | H   |   |                                     |
| <b>AT16</b>   | <b>19865,-</b> | 4110    | 3210 | 2440 | 3340 | 750 | 232 kg<br>3.469 m <sup>3</sup><br>12 szt. | AT02L+3xAT04+AT05+AT02P+5xAT03+AT06 |

| Dodatkowa dopłata |                 |           |           |           |           |
|-------------------|-----------------|-----------|-----------|-----------|-----------|
| III grupa cenowa  | IV grupa cenowa | Stolik x1 | Stolik x2 | Stolik x3 | Stolik x4 |
| 3220,-            | 5606,-          | 545,-     | 1090,-    | 1635,-    | 2180,-    |

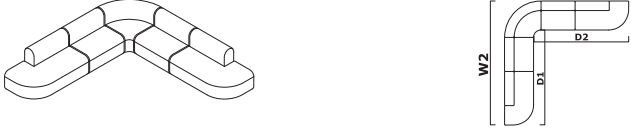
|  |                |         |      |      |      |     |   |                                     |
|---|----------------|---------|------|------|------|-----|---|-------------------------------------|
| Symbol  | Cena netto PLN | Wymiary |      |      |      |     | Waga Obj. Opak.                           | Elementy składowe                   |
|   |                | W1      | W2   | D1   | D2   | H   |   |                                     |
| <b>AT26</b>   | <b>17175,-</b> | 3210    | 3210 | 2440 | 2440 | 750 | 199 kg<br>3.041 m <sup>3</sup><br>10 szt. | AT02L+2xAT04+AT05+AT02P+4xAT03+AT06 |

| Dodatkowa dopłata |                 |           |           |           |  |
|-------------------|-----------------|-----------|-----------|-----------|--|
| III grupa cenowa  | IV grupa cenowa | Stolik x1 | Stolik x2 | Stolik x3 |  |
| 2772,-            | 4824,-          | 545,-     | 1090,-    | 1635,-    |  |

|  |                |         |      |    |    |     |   |                    |
|--|----------------|---------|------|----|----|-----|---|--------------------|
| Symbol   | Cena netto PLN | Wymiary |      |    |    |     | Waga Obj. Opak.                         | Elementy składowe  |
|  |                | W1      | W2   | D1 | D2 | H   |   |                    |
| <b>AT13</b>  | <b>8265,-</b>  | 1940    | 1280 |    |    | 750 | 86 kg<br>1.118 m <sup>3</sup><br>4 szt. | 2xAT01+2xAT04+AT03 |

| Dodatkowa dopłata |                 |           |           |  |  |
|-------------------|-----------------|-----------|-----------|--|--|
| III grupa cenowa  | IV grupa cenowa | Stolik x1 | Stolik x2 |  |  |
| 1304,-            | 2236,-          | 545,-     | 1090,-    |  |  |

|  |                |         |      |    |    |     |  |                      |
|---|----------------|---------|------|----|----|-----|--|----------------------|
| Symbol  | Cena netto PLN | Wymiary |      |    |    |     | Waga Obj. Opak.                          | Elementy składowe    |
|   |                | W1      | W2   | D1 | D2 | H   |  |                      |
| <b>AT10</b>   | <b>12270,-</b> | 2840    | 1280 |    |    | 750 | 118 kg<br>1.577 m <sup>3</sup><br>6 szt. | 2xAT01+4xAT04+2xAT03 |

| Dodatkowa dopłata |                 |           |           |           |           |
|-------------------|-----------------|-----------|-----------|-----------|-----------|
| III grupa cenowa  | IV grupa cenowa | Stolik x1 | Stolik x2 | Stolik x3 | Stolik x4 |
| 1940,-            | 3342,-          | 545,-     | 1090,-    | 1635,-    | 2180,-    |

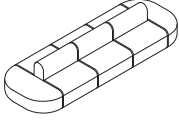
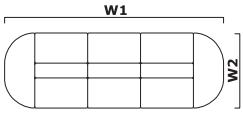
|   |                |         |      |    |    |     |  |                      |
|---|----------------|---------|------|----|----|-----|--|----------------------|
| Symbol  | Cena netto PLN | Wymiary |      |    |    |     | Waga Obj. Opak.                          | Elementy składowe    |
|   |                | W1      | W2   | D1 | D2 | H   |  |                      |
| <b>AT14</b>   | <b>16275,-</b> | 3740    | 1280 |    |    | 750 | 150 kg<br>2.035 m <sup>3</sup><br>8 szt. | 2xAT01+6xAT04+3xAT03 |

| Dodatkowa dopłata |                 |           |           |           |           |           |
|-------------------|-----------------|-----------|-----------|-----------|-----------|-----------|
| III grupa cenowa  | IV grupa cenowa | Stolik x1 | Stolik x2 | Stolik x3 | Stolik x4 | Stolik x5 |
| 2576,-            | 4448,-          | 545,-     | 1090,-    | 1635,-    | 2180,-    | 2725,-    |

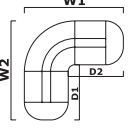
|   |                |         |      |      |      |     |  |                                     |
|---|----------------|---------|------|------|------|-----|--|-------------------------------------|
| Symbol  | Cena netto PLN | Wymiary |      |      |      |     | Waga Obj. Opak.                          | Elementy składowe                   |
|   |                | W1      | W2   | D1   | D2   | H   |  |                                     |
| <b>AT22</b>   | <b>18135,-</b> | 2820    | 2820 | 1540 | 1540 | 750 | 162 kg<br>2.586 m <sup>3</sup><br>8 szt. | 2xAT01+4xAT04+AT05+AT07+2xAT03+AT06 |

| Dodatkowa dopłata |                 |           |           |           |           |
|-------------------|-----------------|-----------|-----------|-----------|-----------|
| III grupa cenowa  | IV grupa cenowa | Stolik x1 | Stolik x2 | Stolik x3 | Stolik x4 |
| 2982,-            | 5146,-          | 545,-     | 1090,-    | 1635,-    | 2180,-    |

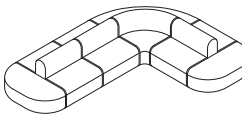
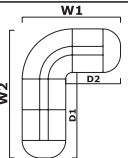
|   |                |         |      |      |      |     |   |                                     |
|---|----------------|---------|------|------|------|-----|---|-------------------------------------|
| Symbol  | Cena netto PLN | Wymiary |      |      |      |     | Waga Obj. Opak.                           | Elementy składowe                   |
|   |                | W1      | W2   | D1   | D2   | H   |   |                                     |
| <b>AT09</b>   | <b>22140,-</b> | 2820    | 3720 | 2440 | 1540 | 750 | 194 kg<br>3.044 m <sup>3</sup><br>10 szt. | 2xAT01+6xAT04+AT05+AT07+3xAT03+AT06 |

| Dodatkowa dopłata |                 |           |           |           |           |           |
|-------------------|-----------------|-----------|-----------|-----------|-----------|-----------|
| III grupa cenowa  | IV grupa cenowa | Stolik x1 | Stolik x2 | Stolik x3 | Stolik x4 | Stolik x5 |
| 3618,-            | 6252,-          | 545,-     | 1090,-    | 1635,-    | 2180,-    | 2725,-    |

| Symbol      | Cena netto PLN | Wymiary |      |      |      |     | Waga Obj. Opak.                           | Elementy składowe                   |
|-------------|----------------|---------|------|------|------|-----|---|-------------------------------------|
|             |                | W1      | W2   | D1   | D2   | H   |   |                                     |
| <b>AT25</b> | <b>26145,-</b> | 3720    | 3720 | 2440 | 2440 | 750 | 226 kg<br>3.503 m <sup>3</sup><br>12 szt. | 2xAT01+8xAT04+AT05+AT07+4xAT03+AT06 |

| Dodatkowa dopłata |                 |           |           |           |           |           |
|-------------------|-----------------|-----------|-----------|-----------|-----------|-----------|
| III grupa cenowa  | IV grupa cenowa | Stolik x1 | Stolik x2 | Stolik x3 | Stolik x4 | Stolik x5 |
| 4254,-            | 7358,-          | 545,-     | 1090,-    | 1635,-    | 2180,-    | 2725,-    |

| Symbol      | Cena netto PLN | Wymiary |      |    |    |     | Waga Obj. Opak.                        | Elementy składowe |
|-------------|----------------|---------|------|----|----|-----|--|-------------------|
|             |                | W1      | W2   | D1 | D2 | H   |  |                   |
| <b>AT12</b> | <b>4260,-</b>  | 1280    | 1040 |    |    | 450 | 54 kg<br>0.66 m <sup>3</sup><br>2 szt. | 2xAT01            |

| Dodatkowa dopłata |                 |           |  |  |  |  |
|-------------------|-----------------|-----------|--|--|--|--|
| III grupa cenowa  | IV grupa cenowa | Stolik x1 |  |  |  |  |
| 668,-             | 1130,-          | 545,-     |  |  |  |  |

| Symbol      | Cena netto PLN | Wymiary |      |    |    |     | Waga Obj. Opak.                          | Elementy składowe |
|-------------|----------------|---------|------|----|----|-----|--|-------------------|
|             |                | W1      | W2   | D1 | D2 | H   |  |                   |
| <b>AT20</b> | <b>18040,-</b> | 2820    | 2820 |    |    | 750 | 128 kg<br>3.023 m <sup>3</sup><br>4 szt. | 4xAT07+4xAT06     |

| Dodatkowa dopłata |                 |           |           |           |           |  |
|-------------------|-----------------|-----------|-----------|-----------|-----------|--|
| III grupa cenowa  | IV grupa cenowa | Stolik x1 | Stolik x2 | Stolik x3 | Stolik x4 |  |
| 3336,-            | 5760,-          | 545,-     | 1090,-    | 1635,-    | 2180,-    |  |

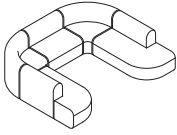
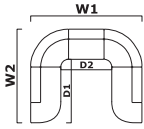

|  |                |  |      |      |      |     |   |                                       |
|---|----------------|---|------|------|------|-----|---|---------------------------------------|
| Symbol  | Cena netto PLN | Wymiary   |      |      |      |     | Waga Obj. Opak.                           | Elementy składowe                     |
|   |                | W1  | W2   | D1   | D2   | H   |   |                                       |
| <b>AT27</b>   | <b>17990,-</b> | 2700  | 2310 | 1540 | 1160 | 750 | 201 kg<br>3.334 m <sup>3</sup><br>10 szt. | AT02L+2xAT05+AT04+AT02P+3xAT03+2xAT06 |

| Dodatkowa dopłata |                 |           |           |  |  |
|-------------------|-----------------|-----------|-----------|--|--|
| III grupa cenowa  | IV grupa cenowa | Stolik x1 | Stolik x2 |  |  |
| 2928,-            | 5096,-          | 545,-     | 1090,-    |  |  |

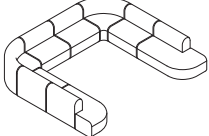
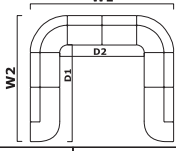
|  |                |  |      |      |      |     |   |   |
|--|----------------|--|------|------|------|-----|---|---|
| Symbol   | Cena netto PLN | Wymiary  |      |      |      |     | Waga Obj. Opak.                           | Elementy składowe                       |
|  |                | W1   | W2   | D1   | D2   | H   |   |   |
| <b>AT21</b>  | <b>26060,-</b> | 3600   | 3210 | 2440 | 2060 | 750 | 300 kg<br>4.617 m <sup>3</sup><br>16 szt. | AT02L+4xAT04+2xAT05+AT02P+6xAT03+2xAT06 |

| Dodatkowa dopłata |                 |           |           |           |  |
|-------------------|-----------------|-----------|-----------|-----------|--|
| III grupa cenowa  | IV grupa cenowa | Stolik x1 | Stolik x2 | Stolik x3 |  |
| 4272,-            | 7442,-          | 545,-     | 1090,-    | 1635,-    |  |

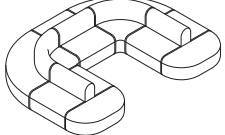
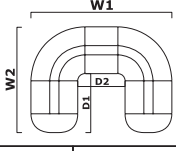
|  |                |  |      |      |      |     |   |   |
|---|----------------|---|------|------|------|-----|---|---|
| Symbol  | Cena netto PLN | Wymiary   |      |      |      |     | Waga Obj. Opak.                           | Elementy składowe                         |
|   |                | W1  | W2   | D1   | D2   | H   |   |   |
| <b>AT17</b>   | <b>28005,-</b> | 3720  | 2820 | 1540 | 1160 | 750 | 335 kg<br>5.582 m <sup>3</sup><br>17 szt. | 2xAT01+6xAT04+2xAT05+2xAT07+3xAT03+2xAT06 |



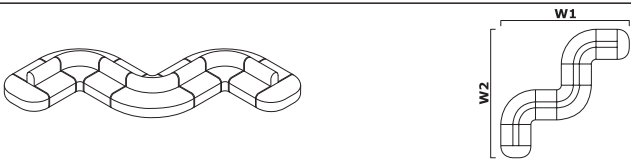

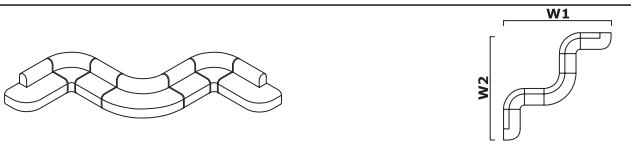

| Dodatkowa dopłata |                 |           |           |           |           |
|-------------------|-----------------|-----------|-----------|-----------|-----------|
| III grupa cenowa  | IV grupa cenowa | Stolik x1 | Stolik x2 | Stolik x3 | Stolik x4 |
| 4660,-            | 8056,-          | 545,-     | 1090,-    | 1635,-    | 2180,-    |
|                   |                 |           |           |           | 2725,-    |

|   |                   |         |      |    |    |     |   |   |
|---|-------------------|---------|------|----|----|-----|---|---|
|  |                   | Wymiary |      |    |    |     | Waga<br>Obj.<br>Opak.                     | Elementy składowe                         |
|   |                   | W1      | W2   | D1 | D2 | H   |   |   |
| Symbol  | Cena netto<br>PLN | 5250    | 5250 |    |    | 750 | 451 kg<br>7.715 m <sup>3</sup><br>23 szt. | 2xAT01+8xAT04+3xAT05+3xAT07+4xAT03+3xAT06 |

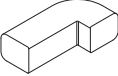
| Dodatkowa dopłata |                 |           |           |           |           |
|-------------------|-----------------|-----------|-----------|-----------|-----------|
| III grupa cenowa  | IV grupa cenowa | Stolik x1 | Stolik x2 | Stolik x3 | Stolik x4 |
| 6338,-            | 10966,-         | 545,-     | 1090,-    | 1635,-    | 2180,-    |
|                   |                 |           |           |           | 2725,-    |

|  |                   |         |      |    |    |     |   |  |
|--|-------------------|---------|------|----|----|-----|---|--|
|  |                   | Wymiary |      |    |    |     | Waga<br>Obj.<br>Opak.                     | Elementy składowe                            |
|  |                   | W1      | W2   | D1 | D2 | H   |   |  |
| Symbol   | Cena netto<br>PLN | 4740    | 4740 |    |    | 750 | 289 kg<br>4.984 m <sup>3</sup><br>14 szt. | AT02L+2xAT05+2xAT04+AT07+AT02P+4xAT03+3xAT06 |

| Dodatkowa dopłata |                 |           |           |           |           |
|-------------------|-----------------|-----------|-----------|-----------|-----------|
| III grupa cenowa  | IV grupa cenowa | Stolik x1 | Stolik x2 | Stolik x3 | Stolik x4 |
| 4210,-            | 7318,-          | 545,-     | 1090,-    | 1635,-    | 2180,-    |
|                   |                 |           |           |           |           |

| Elementy składowe   |              |                |         |     |      |                             | Dodatkowa dopłata |                  |          |                 |  |  |  |  |  |
|---|--------------|----------------|---------|-----|------|-----------------------------|-------------------|------------------|----------|-----------------|--|--|--|--|--|
|   | Symbol       | Cena netto PLN | Wymiary |     |      | Waga<br>Obj.<br>Opak.       | Uwagi             | III grupa cenowa | Mediabox | IV grupa cenowa |  |  |  |  |  |
|   |              |                | Szer.   | Gł. | Wys. |                             |                   |                  |          |                 |  |  |  |  |  |
|    | <b>AT01</b>  | <b>2130,-</b>  | 1280    | 520 | 450  | 27 kg<br>0.33 m3<br>1 szt.  |                   | 334,-            | 575,-    | 565,-           |  |  |  |  |  |
|    | <b>AT02L</b> | <b>2770,-</b>  | 1420    | 770 | 450  | 32 kg<br>0.535 m3<br>1 szt. |                   | 376,-            | 575,-    | 645,-           |  |  |  |  |  |
|   | <b>AT02P</b> | <b>2770,-</b>  | 1420    | 770 | 450  | 32 kg<br>0.535 m3<br>1 szt. |                   | 376,-            | 575,-    | 645,-           |  |  |  |  |  |
|  | <b>AT03</b>  | <b>1375,-</b>  | 900     | 510 | 750  | 17 kg<br>0.198 m3<br>1 szt. |                   | 260,-            |          | 458,-           |  |  |  |  |  |
|  | <b>AT04</b>  | <b>1315,-</b>  | 900     | 510 | 450  | 16 kg<br>0.229 m3<br>1 szt. |                   | 188,-            | 575,-    | 324,-           |  |  |  |  |  |
|  | <b>AT05</b>  | <b>1355,-</b>  | 910     | 560 | 450  | 12 kg<br>0.254 m3<br>1 szt. |                   | 208,-            |          | 364,-           |  |  |  |  |  |
|  | <b>AT06</b>  | <b>2150,-</b>  | 1270    | 450 | 750  | 23 kg<br>0.467 m3<br>1 szt. |                   | 396,-            |          | 690,-           |  |  |  |  |  |
|  | <b>AT07</b>  | <b>2360,-</b>  | 1990    | 780 | 450  | 32 kg<br>0.756 m3<br>1 szt. |                   | 438,-            | 575,-    | 750,-           |  |  |  |  |  |

| Bierka   |                |         |     |      |                              |       | Dodatkowa dopłata |  |  |  |  |  |  |  |  |
|--|----------------|---------|-----|------|------------------------------|-------|-------------------|--|--|--|--|--|--|--|--|
| Symbol   | Cena netto PLN | Wymiary |     |      | Waga<br>Obj.<br>Opak.        | Uwagi |                   |  |  |  |  |  |  |  |  |
|  |                | Szer.   | Gł. | Wys. |                              |       |                   |  |  |  |  |  |  |  |  |
|  <b>AT01S</b> | <b>545,-</b>   | 473     | 250 | 630  | 2.8 kg<br>0.087 m3<br>1 szt. |       |                   |  |  |  |  |  |  |  |  |